

Store Coffre 53



FABRICATION
FRANÇAISE



- ☞ Store INTERIEUR ou EXTERIEUR
- ☞ Guidage par cables ou coulisses
- ☞ Manœuvre par Chainette ou Treuil
- ☞ Toiles de Protection Solaire ou Occultantes



Caractéristiques Techniques

Store Coffre 53

RAL Standard:

9010,9016,8019,7035,7022,7016,
9005 ,9006,Anodisé Naturel.

Dimensions:

Largeur : 500 à 2100 mm
Hauteur :500 à 2700 mm

- **Manœuvres:**

Chainette PVC

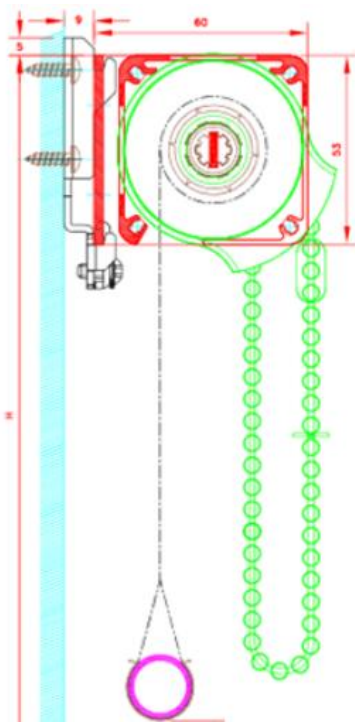

Treuil et manivelle sous coffre

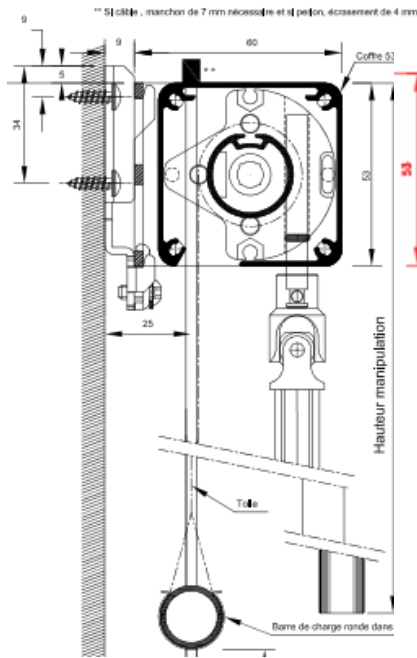

Treuil et manivelle renvoi intérieur 90°

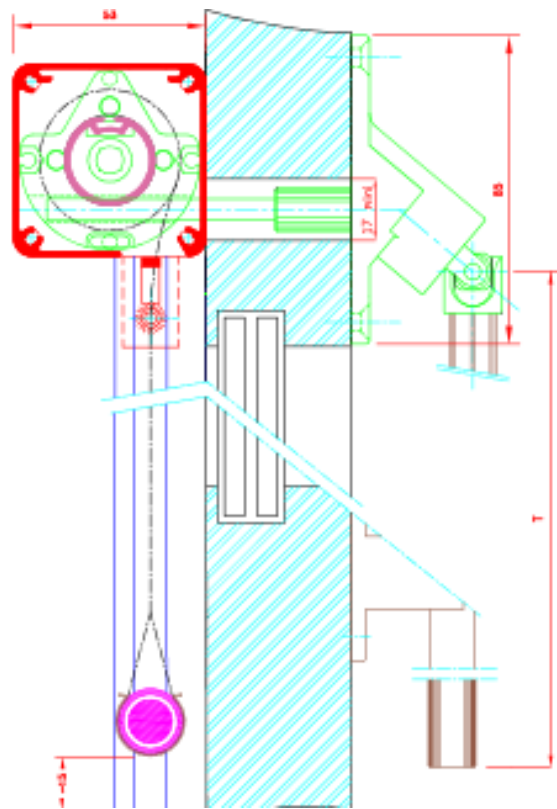

Treuil sortie sous coffre

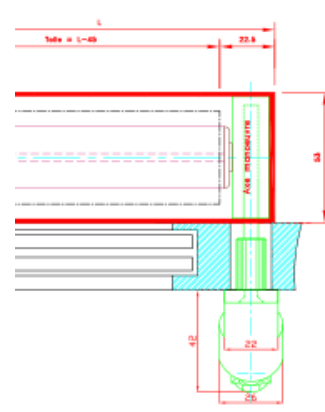
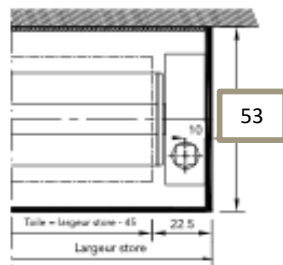



Caractéristiques Techniques

Store Coffre 53

Guidages:

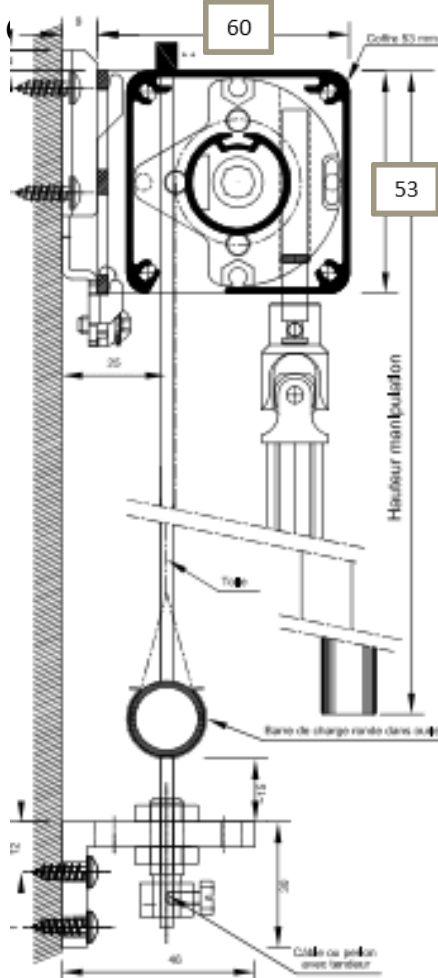
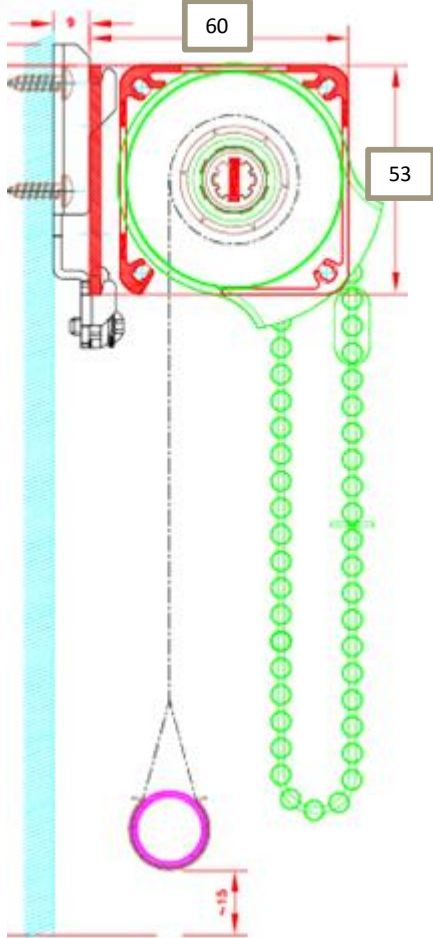

guidage câble

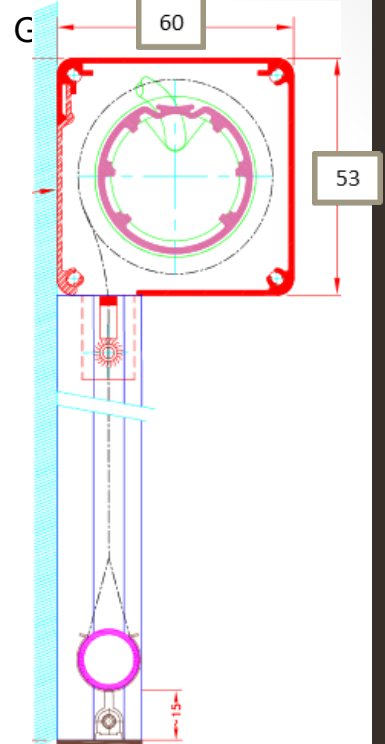

Coulisse Protection Solaire 25x17

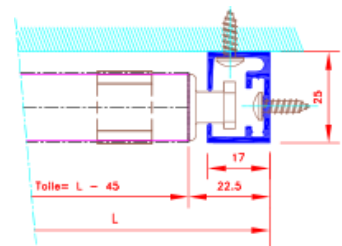

Coulisse occultante 20x35

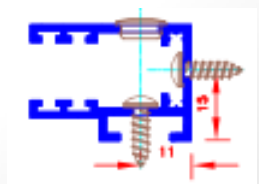
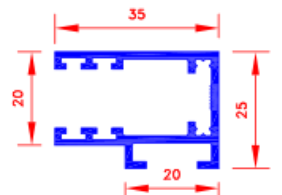

Barre de Charge:

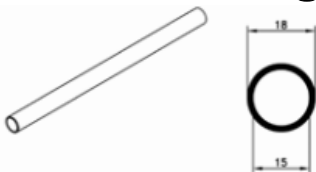

barre de charge ronde en acier électro-zingué dans l'ourlet de la toile
diamètre 15/18 mm,

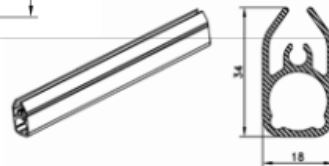
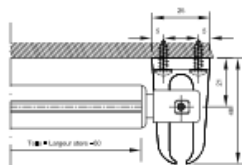
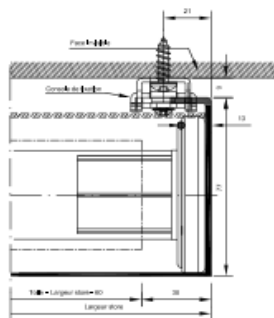

barre de charge en aluminium extrudé 18 x 34 mm

Store Coffre 70

FABRICATION
FRANÇAISE



- ☞ Store INTERIEUR ou EXTERIEUR
- ☞ Guidage par cables ou coulisses
- ☞ Manœuvre par Treuil ou Motorisé 230 V
- ☞ Toiles de Protection Solaire ou Occultante





Caractéristiques Techniques

Store Coffre 70

RAL Standard:

9010,9016,8019,7035,7022,7016,
9005 ,9006,Anodisé Naturel.

Dimensions:

Largeur : 500 à 3100 mm
Hauteur : 500 à 3500 mm

Manœuvres:

Treuil et manivelle sous coffre

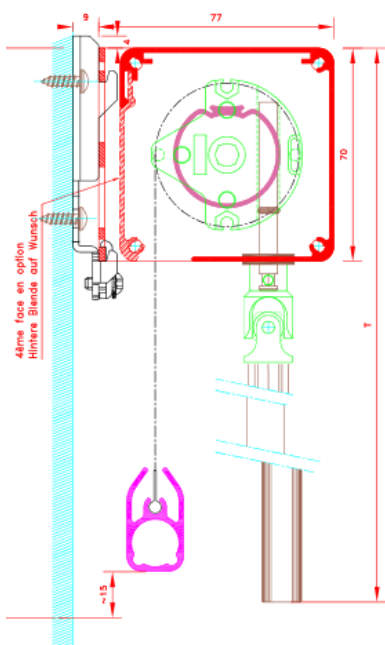

Treuil et manivelle renvoi intérieur 90°

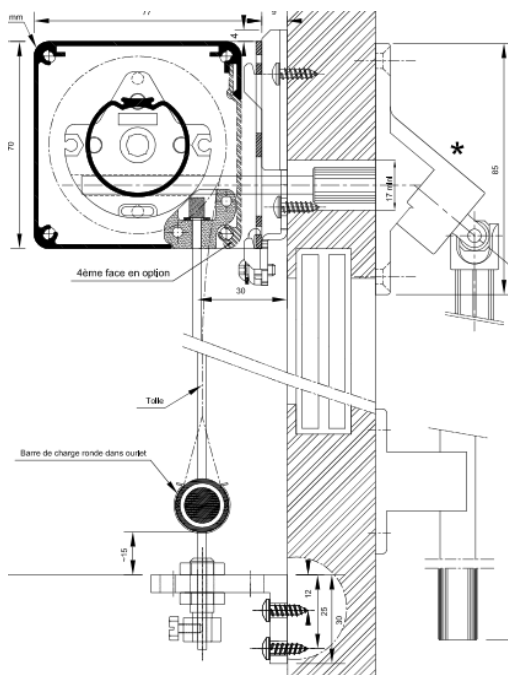

Motorisation 230 V
Filaire ou Radio

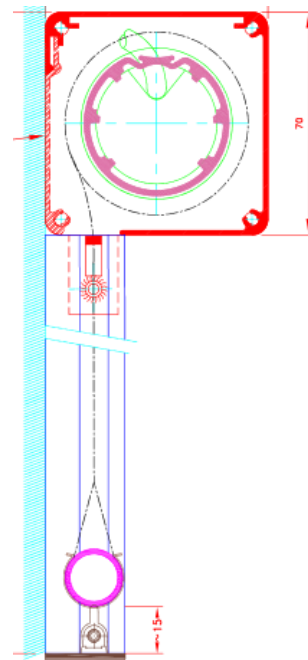

Treuil sortie dessous

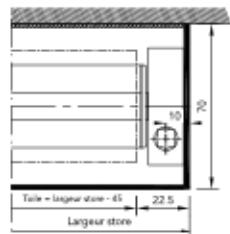

Treuil sortie 90°

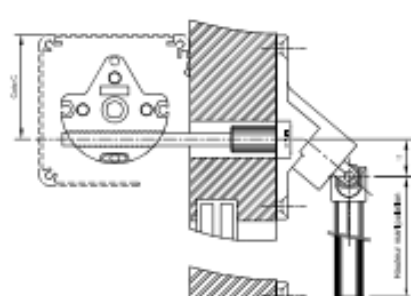

Electrique

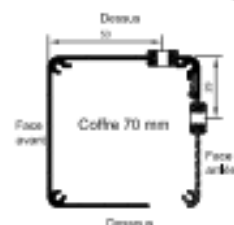
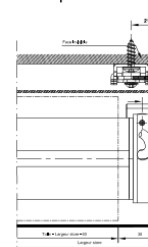



Caractéristiques Techniques Store Coffre 70

Guidages:

Sans Guidage

Guidage Câble acier 3 mm

Guidage Coulisses

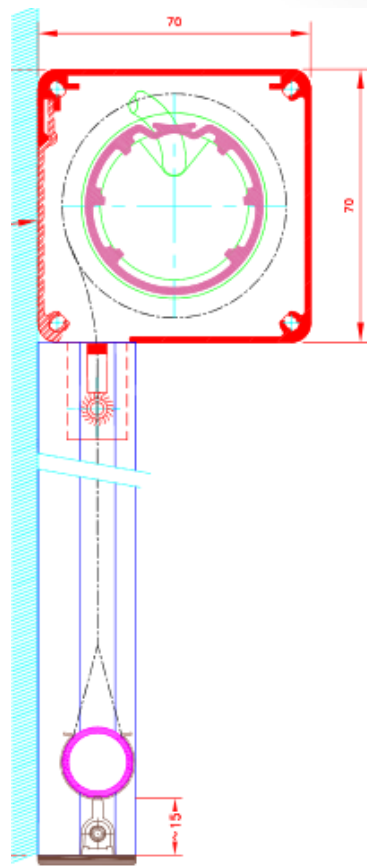
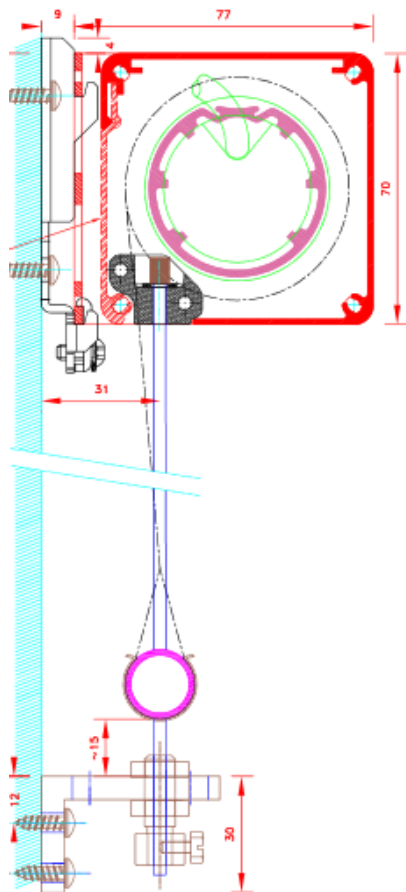
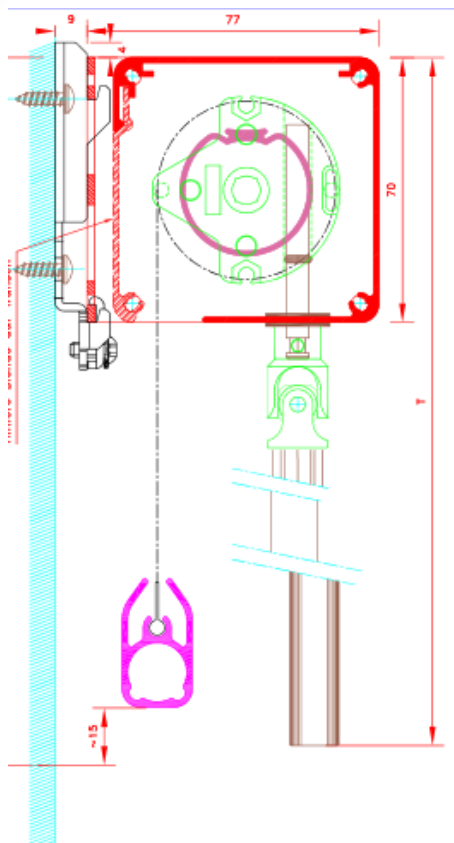

guidage câble

Coulisse 25/17

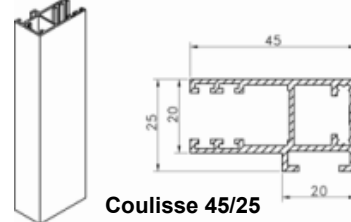
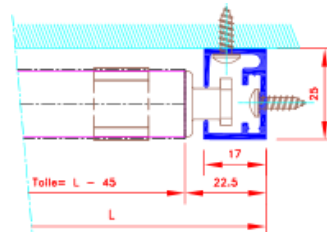

Coulisse 45/25

- largeur de 500 à 2800 mm
- hauteur de 500 à 3000 mm

Possibilités de pose - exemple avec guidage câbles :

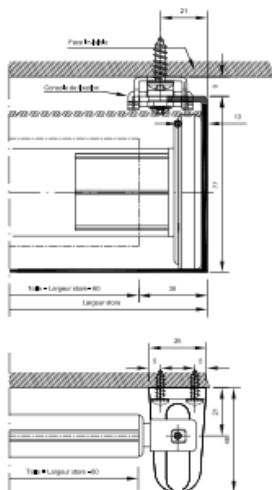
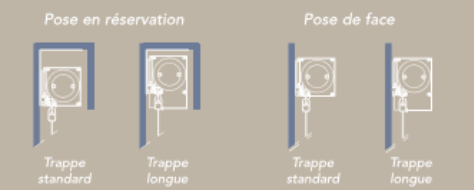

Barre de Charge:

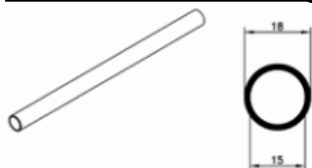

barre de charge ronde en acier électro-zingué dans l'ourlet de la toile diamètre 15/18 mm,



barre de charge en aluminium extrudé 18 x 34 mm

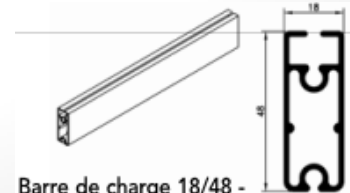

Barre de charge 18/48 -

Store Coffre 95

FABRICATION
FRANÇAISE



- ☞ Store INTERIEUR ou EXTERIEUR
- ☞ Guidage par coulisses
- ☞ Manœuvre Motorisée 230 V Filaire ou Radio
- ☞ Toiles de Protection Solaire ou Occultantes





Caractéristiques Techniques

Store Coffre 95

RAL Standard:

9010,9016,8019,7035,7022,7016,
9005 ,9006,Anodisé Naturel.

Dimensions:

Largeur : 500 à 3800 mm
Hauteur : 500 à 4500 mm

- **Manœuvre:**

Motorisée 230 V Filaire ou Radio

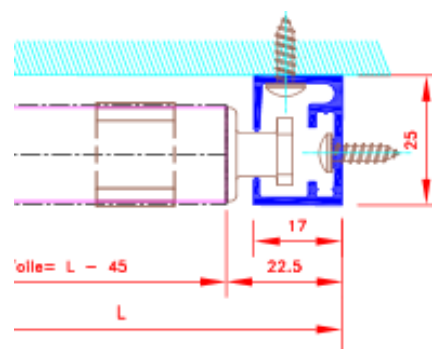
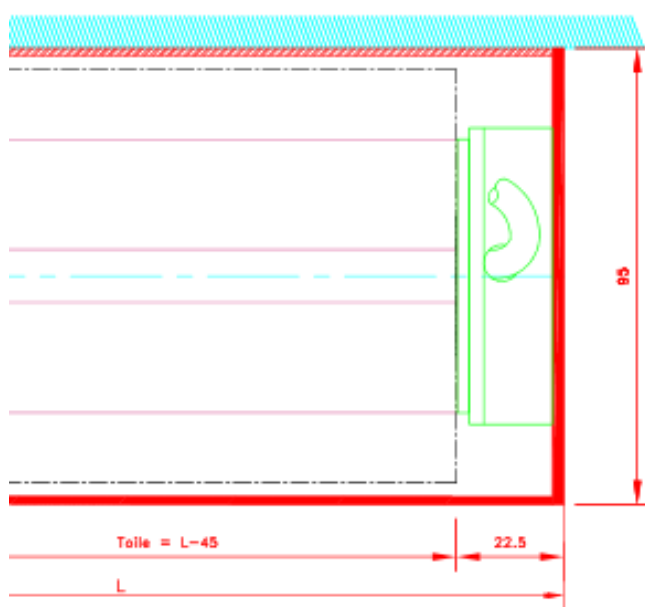
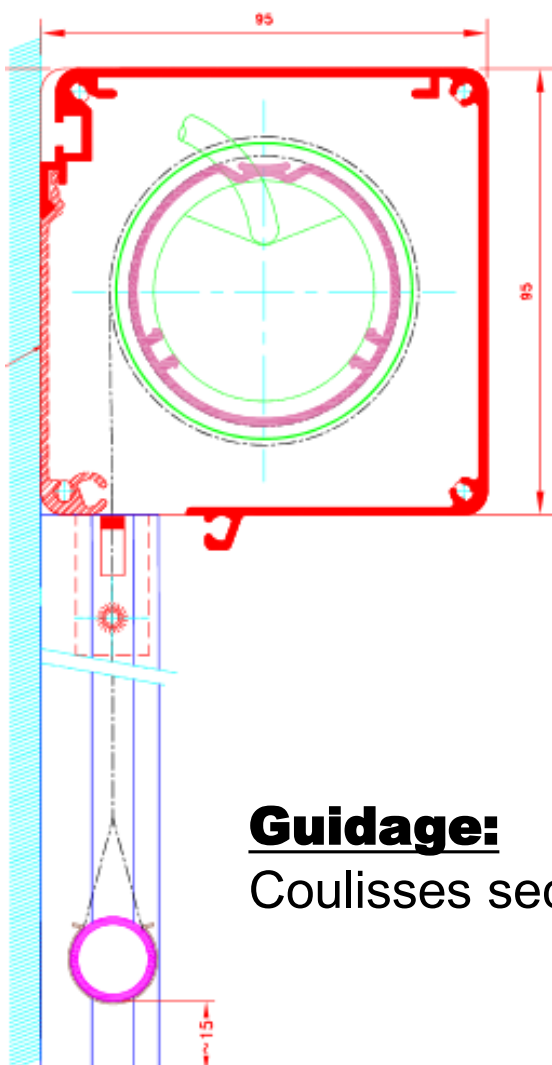

Guidage:

Coulisses section 25x17

Barre de Charge:



barre de charge ronde en acier électro-zingué dans l'ourlet de la toile
diamètre 15/18 mm,